

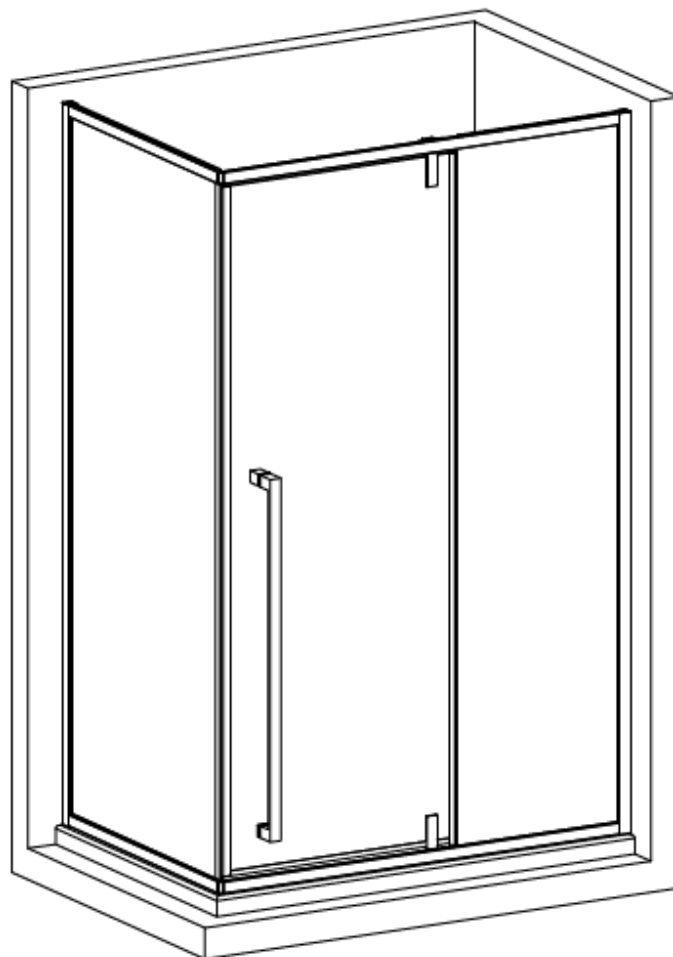

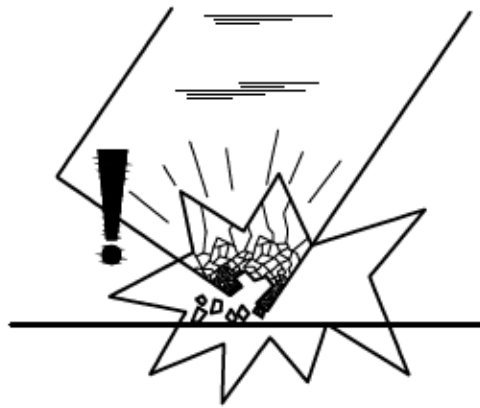

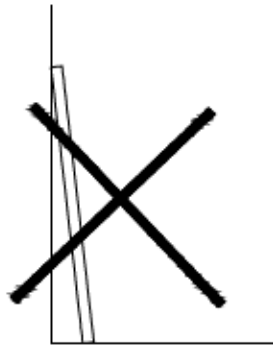

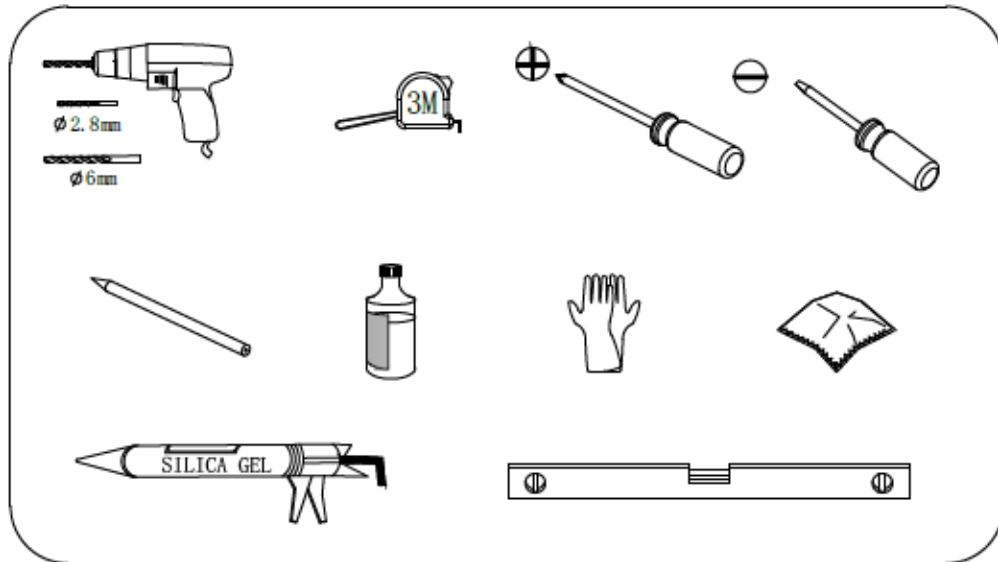





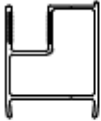



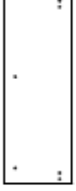



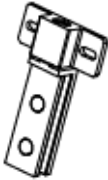



# Návod k montáži – Čtvercový sprchový kout HYD-SK11





Tool:



①  X2	②  X2	③  X2	④  X2
⑤  X2	⑥  X1	⑦  X1	⑧  X1
⑨  X2	⑩  X1	⑪  X2	⑫  X8
⑬  X8	⑭  M5X10 X8	⑮  ST6X16 X4	⑯  ST5X20 X8
⑰  X1	⑱  X1	⑲  X1	⑳  X8
㉑  ST4X30 X16	㉒  ST4X10 X8	㉓  X8	㉔  4# X1

1

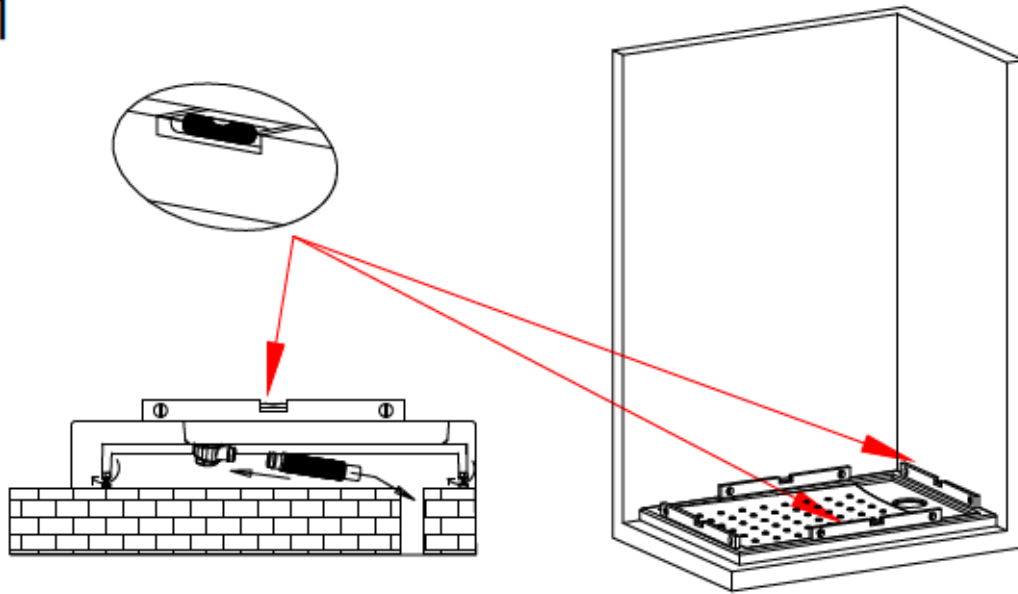

2

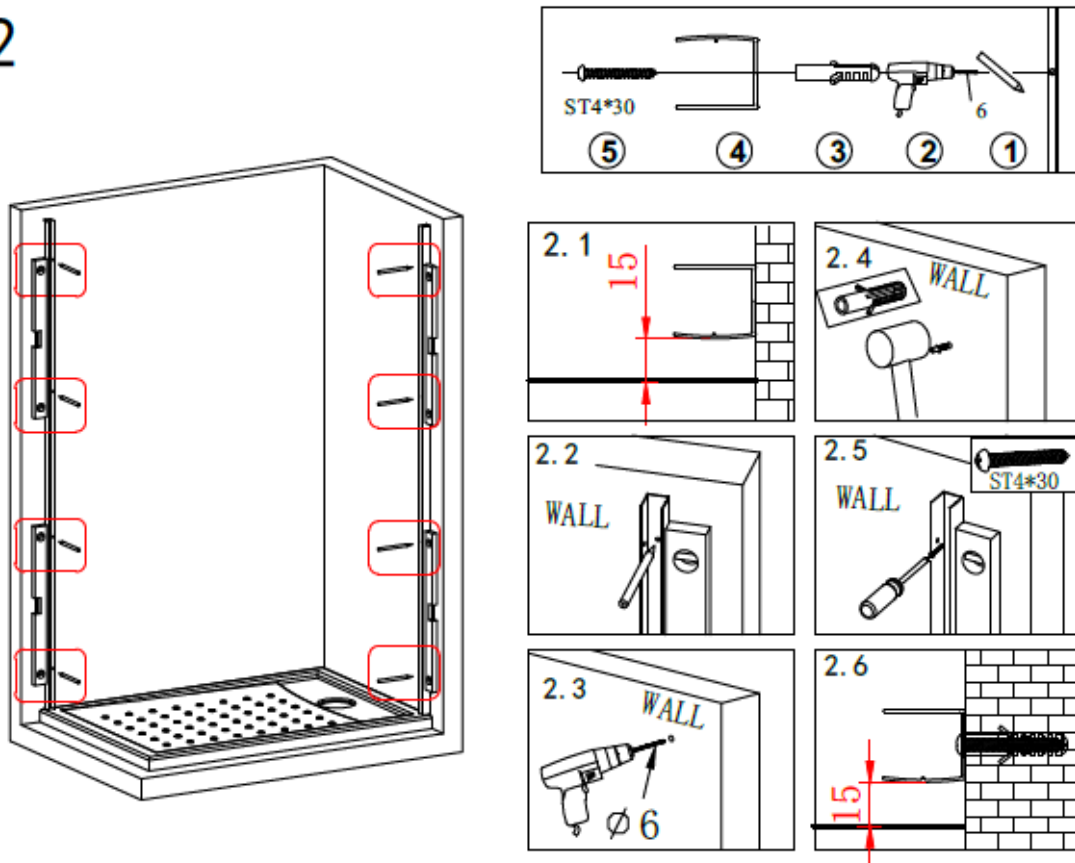

### 3

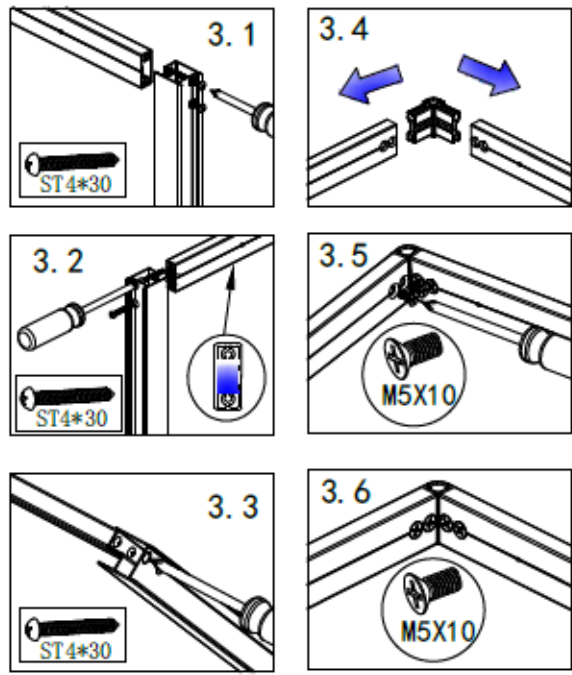
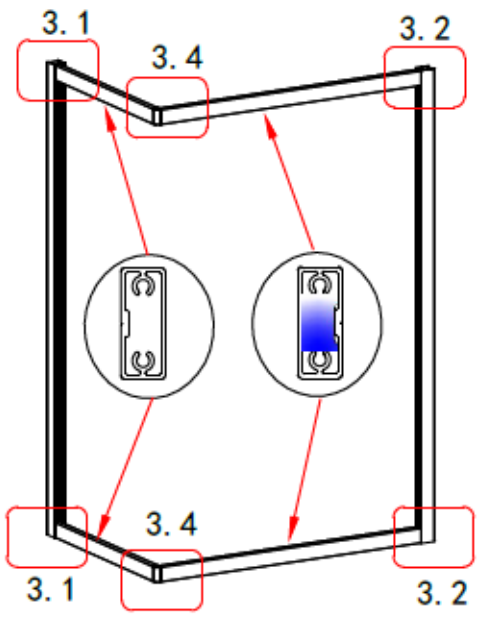

### 4

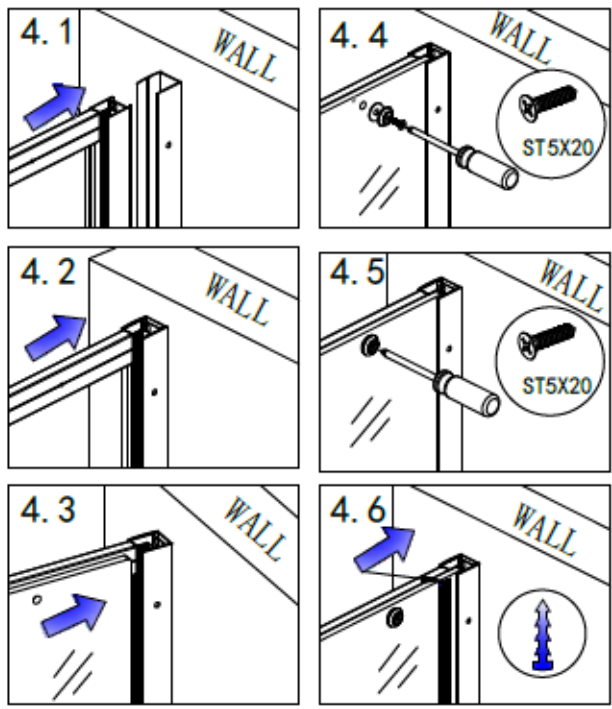
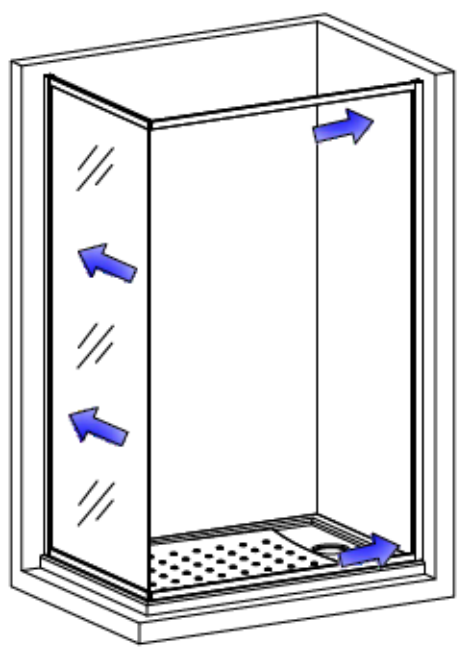

# 5

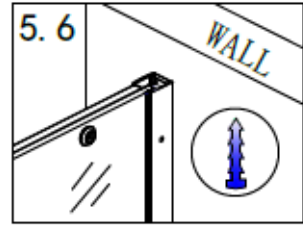
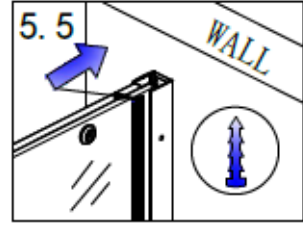
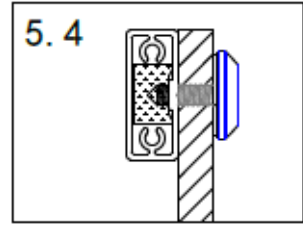
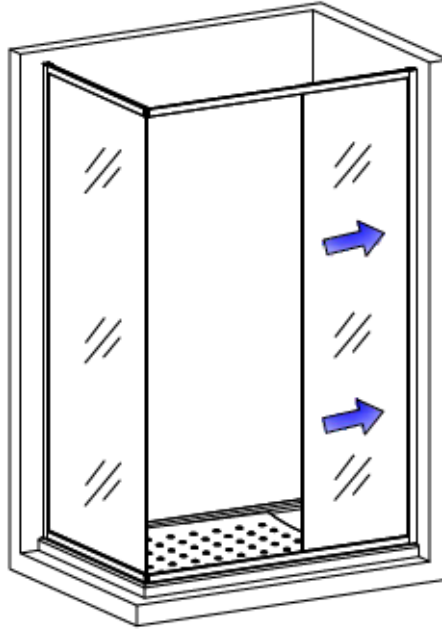
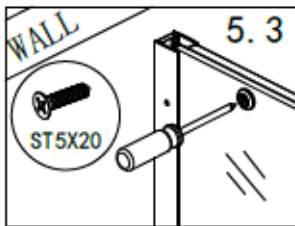
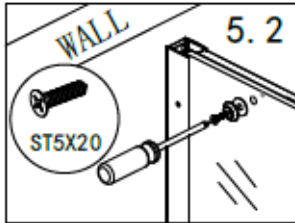
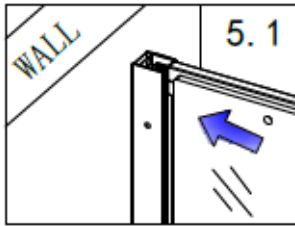

# 6

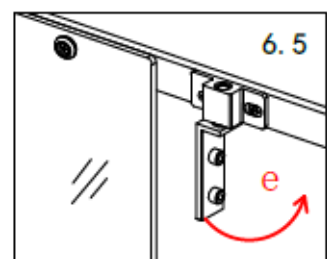
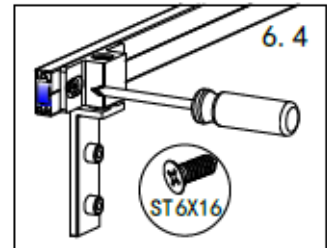
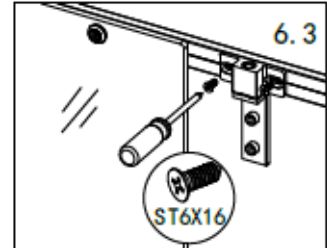
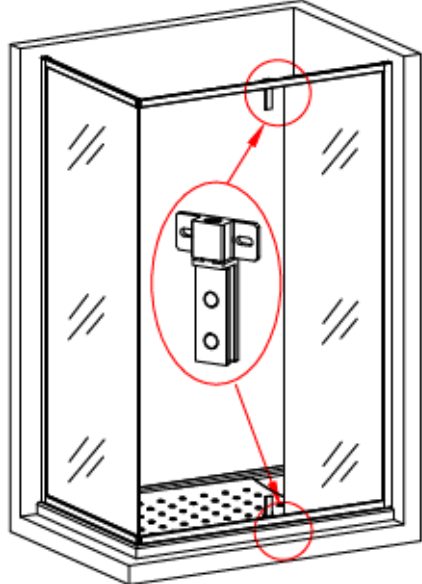
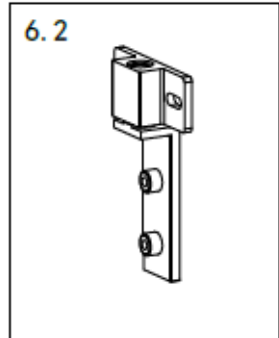
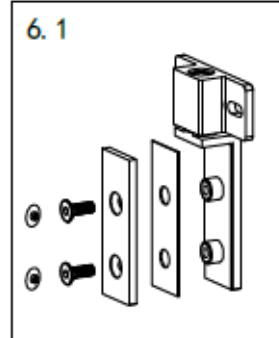

7

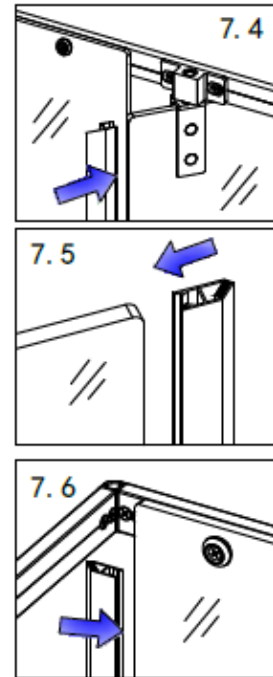
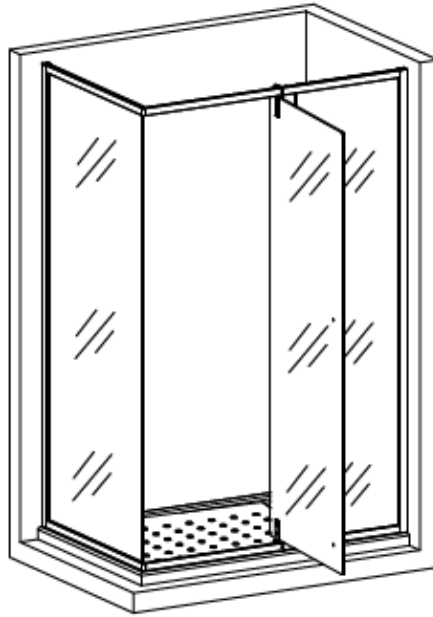
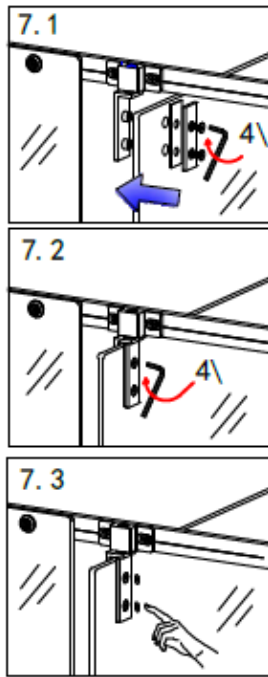

8

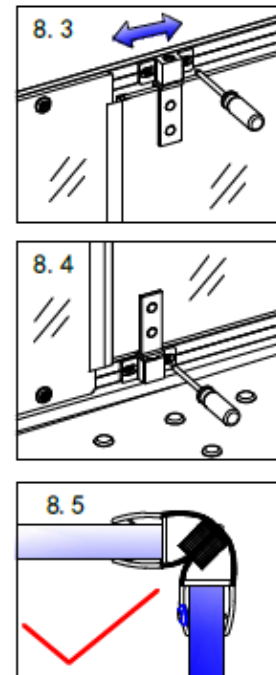
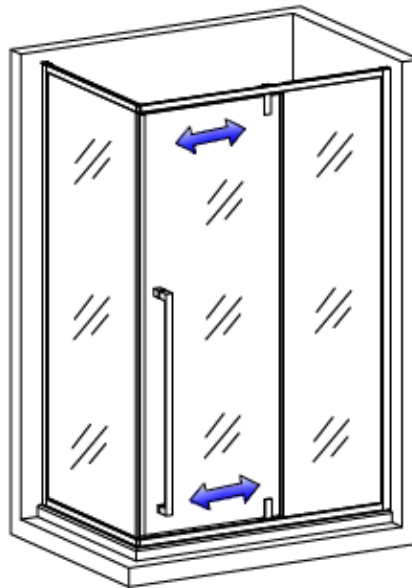
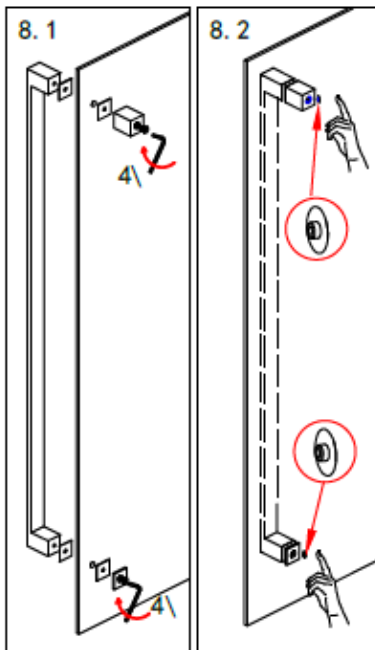

9

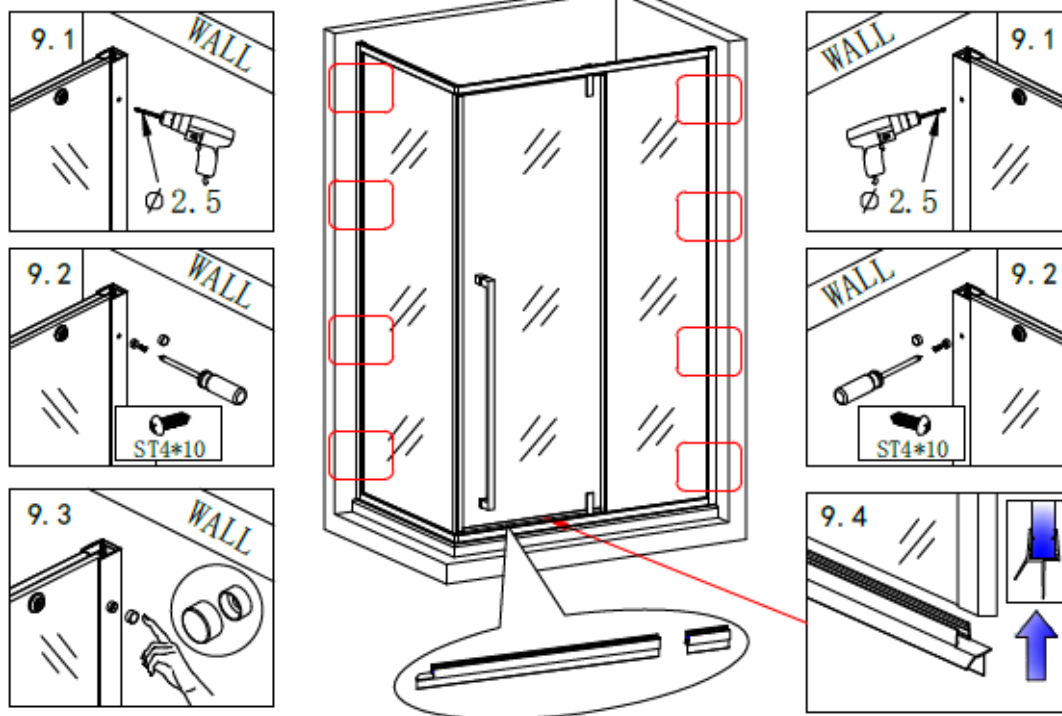

10

